



# POINT OF PURCHASE ASSEMBLY GUIDE

Page 1

Questions?  
**888.373.6057**

or visit  
**wineracksamerica.com**

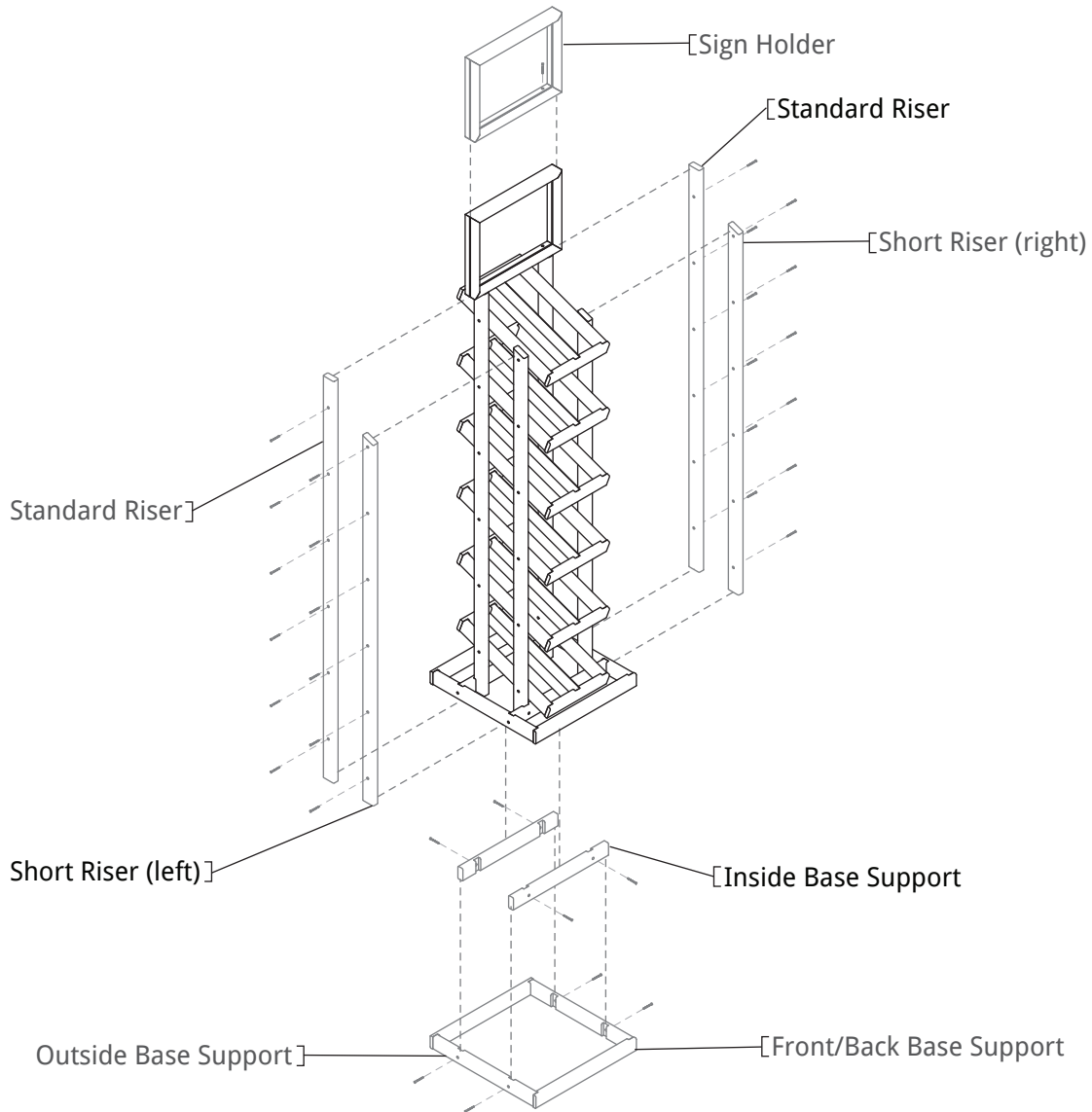

## PACKAGE CONTENTS

## TOOLS FOR ASSEMBLY

\*Please verify that you have the correct number of parts before proceeding.  
Depending on the model you purchased, your bundle should contain the following:

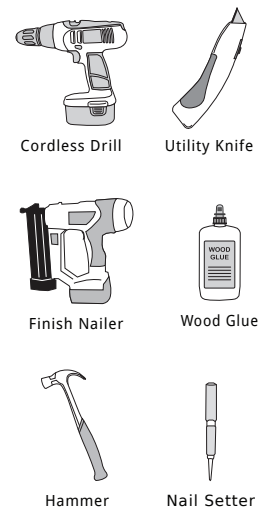
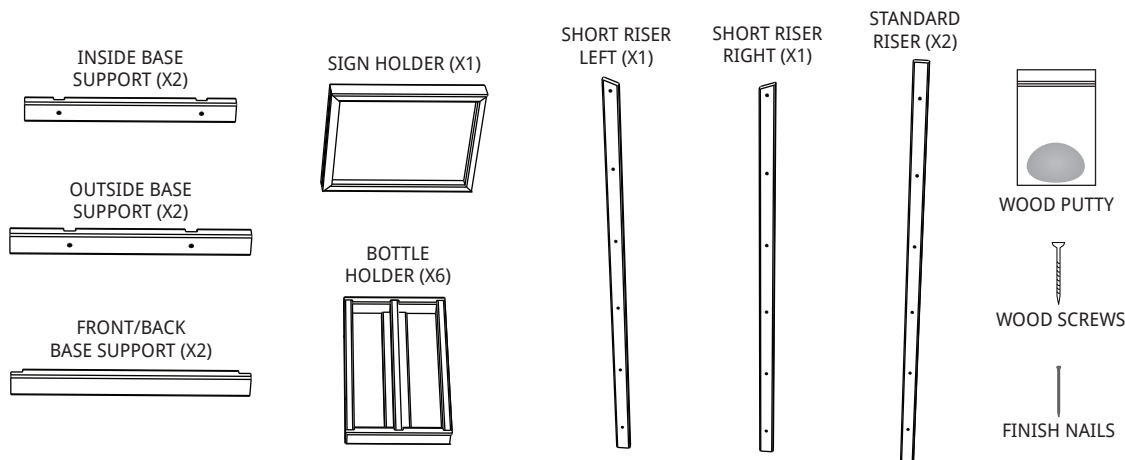



# POINT OF PURCHASE ASSEMBLY GUIDE

Questions?  
**888.373.6057**

or visit  
**wineracksamerica.com**

Page 2

**Step 1:** Place parts on a flat surface. Use a brad nailer or provided finish nails to attach front/back base supports to the outside base supports. Use wood glue for added support. Figure A.

Step 1

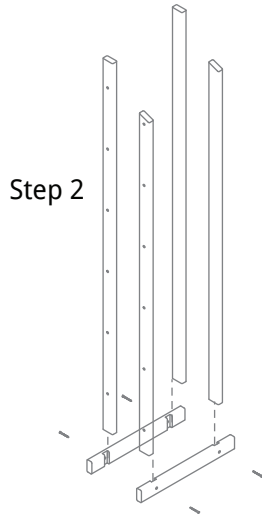
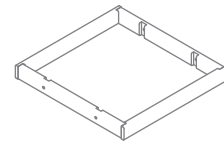

**Step 2:** Attach right and left side risers to the inside base supports using cordless drill or screwdriver.



**Step 3:** Attach risers and inside base supports to the outside base supports using cordless drill or screwdriver.

Step 3

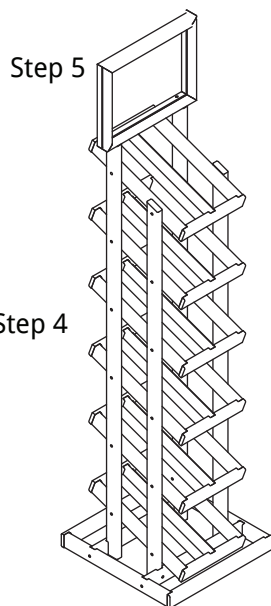

**Step 4:** Attach bottle holders to the risers using a cordless drill or screwdriver. Start screws through risers and use them to align to the pre-drilled holes on the bottle holders. Repeat for all rows.

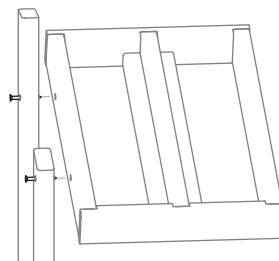

**Step 5:** Attach sign holder to the risers using a cordless drill or screwdriver.